

集水枱 800 X 800 X 800 S= 1 : 2 0

正面圖

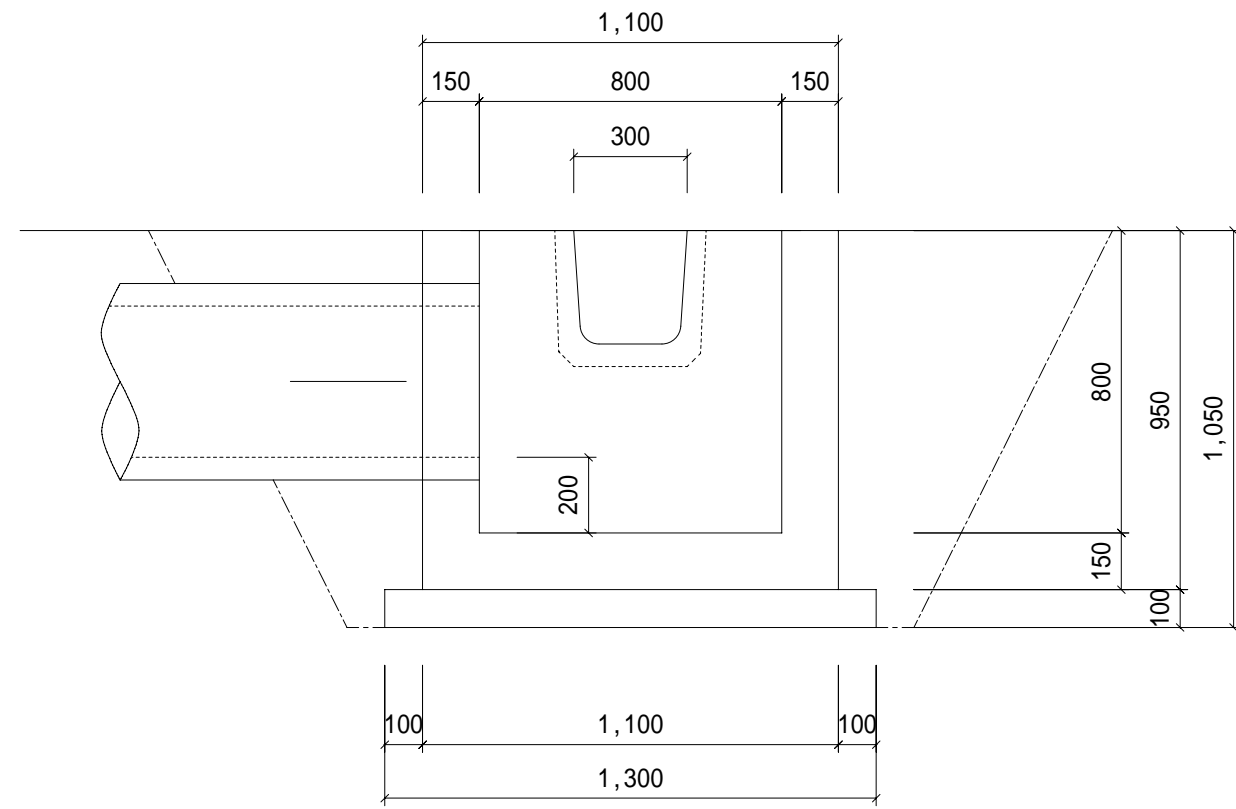

側面圖

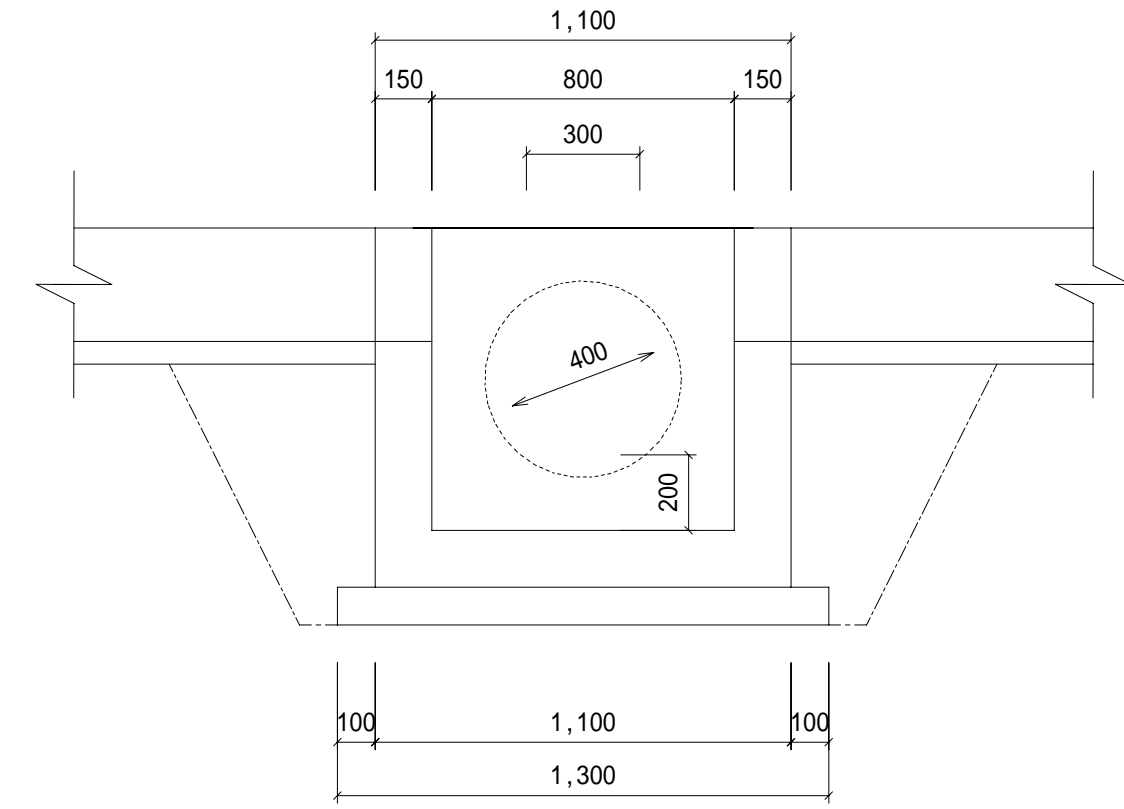

平面圖

