

集水枱 700X700X600 S= 1 : 2 0

正面圖

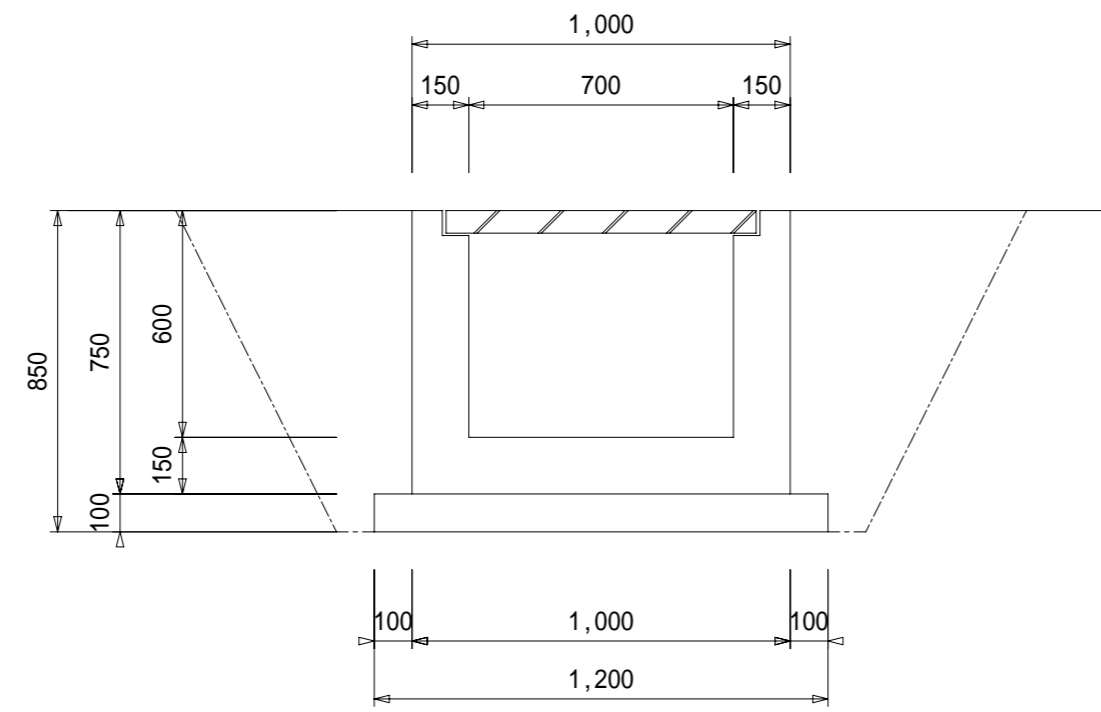

側面圖

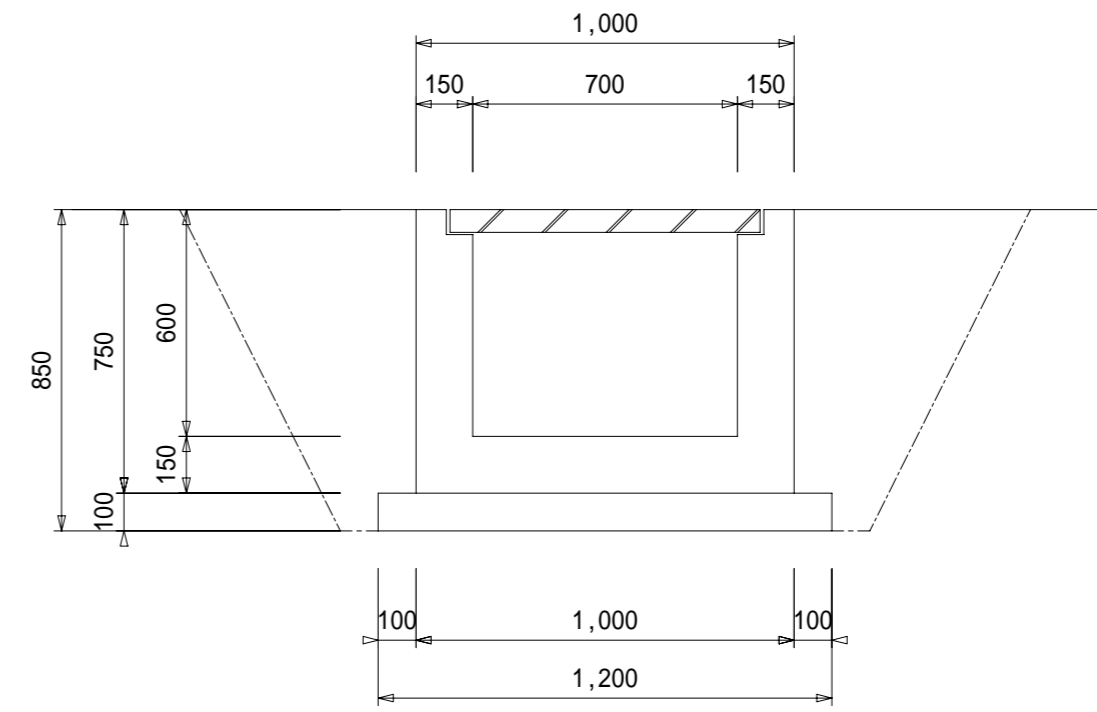

平面圖

